

[www.avfgroup.com](http://www.avfgroup.com)



Read through ALL instructions before commencing assembly.  
If you have any questions about this product or issues with assembly contact the customer services help line before returning this product to the store.



Lisez toutes les instructions avant de débiter l'installation.  
Si vous avez des questions sur ce produit ou sur son installation, contactez le service d'assistance clientèle avant de renvoyer le produit au magasin.



Lea todas las instrucciones antes de empezar la instalación.  
Si usted tiene alguna pregunta acerca de este producto o problemas con la instalación contacte los servicios de ayuda al cliente antes de devolver este producto a la tienda.

CUSTOMER SERVICES HELP LINE NUMBER:  
NUMÉRO DE L'ASSISTANCE CLIENT:  
NUMERO DE SERVICIO DE ATENCION AL CLIENTE:

**+44 (0) 333 320 0463 (UK)**

**AVF Group Ltd.**  
Hortonwood 30, Telford,  
Shropshire, TF1 7YE, England

CUSTOMER SERVICES HELP LINE NUMBER:  
NUMÉRO DE L'ASSISTANCE CLIENT:  
NUMERO DE SERVICIO DE ATENCION AL CLIENTE:

**1-800 667 0808 (USA)**

**AVF Group, Inc.**  
2775 Broadway, Cheektowaga,  
Buffalo, New York, 14227, USA

### **IMPORTANT INFORMATION!**

We advise that before starting the assembly of this product that you familiarise yourself with the instructions and the parts list in this leaflet.

### **INFORMATIONS IMPORTANTES!**

Nous vous recommandons de vous familiariser avec ces instructions et la liste des pièces détachées contenues dans ce document avant de commencer l'assemblage de ce produit.

### **INFORMACIÓN IMPORTANTE!**

Le recomendamos que antes de comenzar el ensamblaje de este producto se familiarize con las instrucciones y la lista de partes en esta hoja informativa.

### **Do not's**

Do not over tighten any part of this assembly.

Do not place hot or cold objects on to or close next to any glass surface unless the object is sufficiently insulated to prevent contact.

Do not strike the glass with hard or pointed items.

Do not sit or stand upon horizontal glass surfaces.

Do not use washing powders or other substances containing abrasives when cleaning the glass.

### **À ne pas faire**

Ne serrez pas trop fort aucun des éléments de cet assemblage.

Ne placez aucun objet froid ou chaud sur ou à proximité de toute surface en verre à moins que celui-ci ne présente une isolation suffisante pour empêcher tout contact.

Ne frappez pas les surfaces en verre avec des objets lourds ou pointus.

Ne vous asseyez ni ne montez pas sur les surfaces horizontales en verre.

N'utilisez pas de poudre à récurer ou toute autre substance abrasive lorsque vous nettoierez les surfaces en verre car cela risquerait de provoquer des rayures.

### **No haga**

No apriete demasiado ninguna de las piezas de este soporte.

No coloque objetos calientes o fríos en o cerca de cualquier superficie de vidrio, a menos que el objeto esté aislado para prevenir contacto directo.

No golpee el vidrio con artículos fuertes o punzantes.

No se siente o se pare en superficies de vidrio.

No use detergentes para lavar u otras sustancias que contengan abrasivos cuando esté limpiando el vidrio ya que estas pueden rayarlo.

### **Do's**

Do use a damp cloth with diluted washing up liquid for cleaning the glass surfaces.

Do use a soft cloth with a suitable furniture polish when cleaning wooden panels.

### **À faire**

Utilisez un chiffon humide imprégné de liquide vaisselle dilué pour le nettoyage des surfaces en verre.

Utilisez un chiffon doux avec un produit adapté pour le nettoyage des meubles afin de nettoyer les panneaux en bois.

### **Si haga**

Use un trapo suave con líquido diluido en agua para limpiar las superficies de vidrio.

Use un trapo suave con limpiador o embellecedor de muebles cuando limpie paneles de madera.

### **Maximum TV size and weight capacity**

TV weight must not exceed 121lbs / 55kgs.

The maximum load for the middle and bottom shelves is 33lbs / 15kgs each.

### **Taille et poids maximaux pour le téléviseur**

Le poids du téléviseur ne doit pas dépasser 121lbs / 55kgs.

La charge maximale pour les étagères du bas et du milieu est de 33lbs / 15kgs pour chaque.

### **Tamaño máximo de la TV y capacidad de peso**

El peso de la TV no debe exceder 121lbs / 55kgs.

La carga máxima para los cajones de en medio es de 33lbs / 15kgs.

### **WARNING**

Wherever possible distribute weight evenly.

### **AVERTISSEMENT**

Répartissez le poids de manière uniforme lorsque cela est possible.

### **ADVERTENCIA**

En la medida de lo posible distribuya el peso uniformemente.

**Boxed Parts**  
*Pièces empaquetées*  
 Piezas en la Caja

**Tools Recommended**  
*Outils recommandés*  
 Herramientas recomendadas

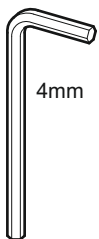
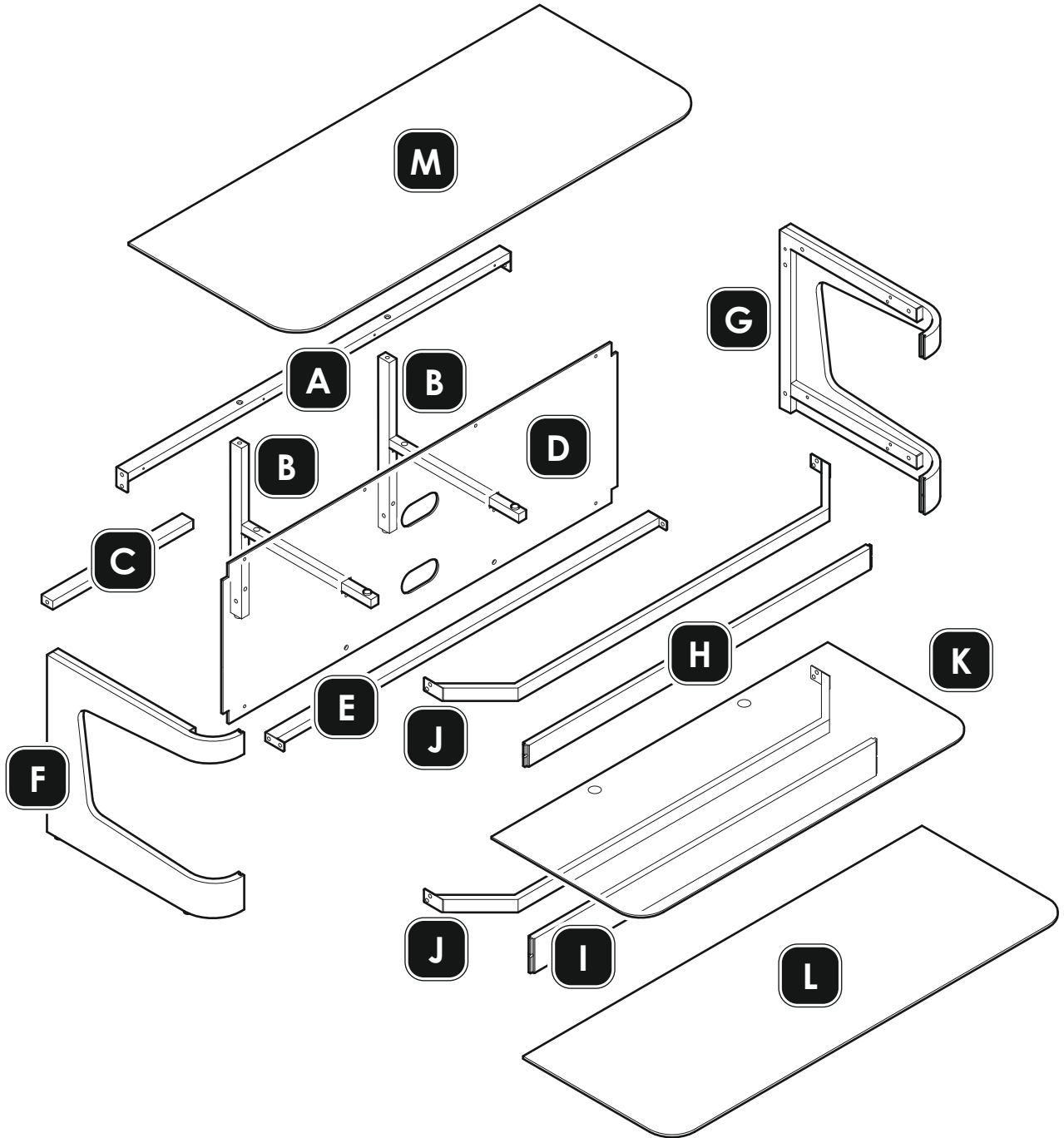
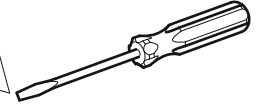
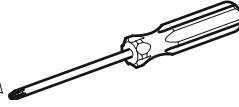

**N**  
x1

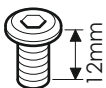

**O**  
x12

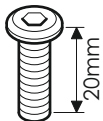

**P**  
x2

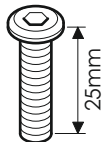

**Q**  
x6

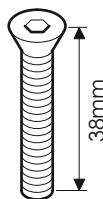

**R**  
x4

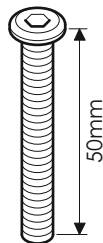

**S**  
x2

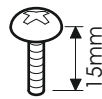

**T**  
x8



**U**  
x4



**V**  
x4



**W**  
x12

1

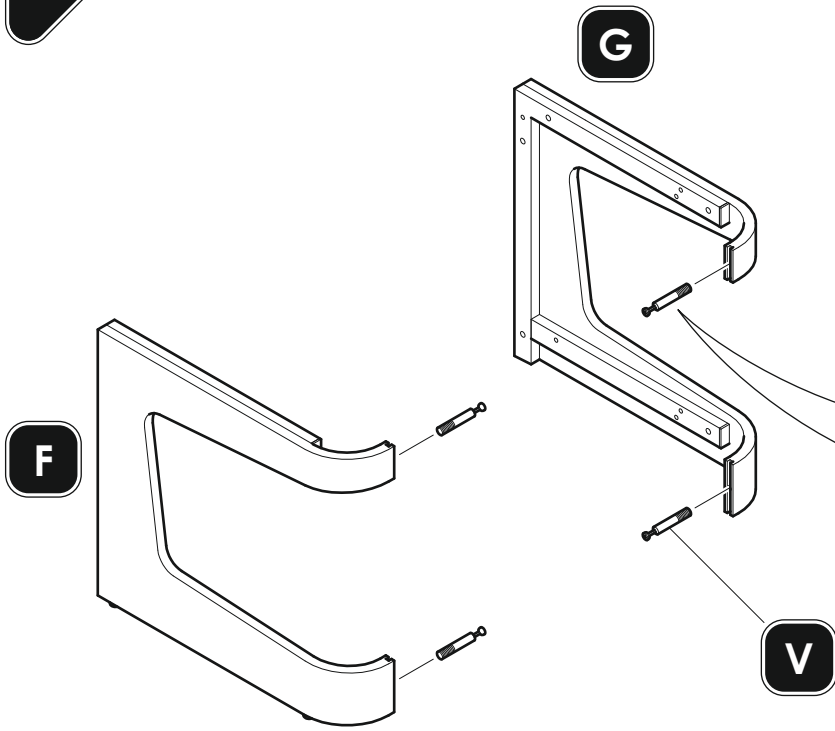

**i**  
Do not over tighten  
Ne serrez pas trop fort  
No apriete demasiado

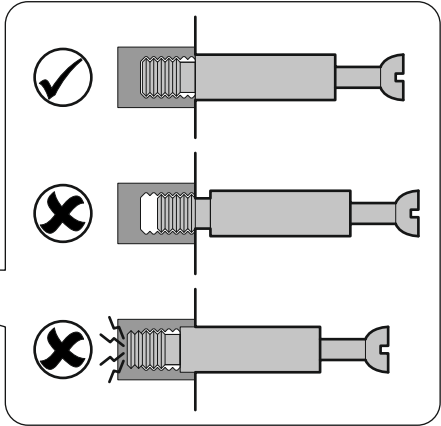

2

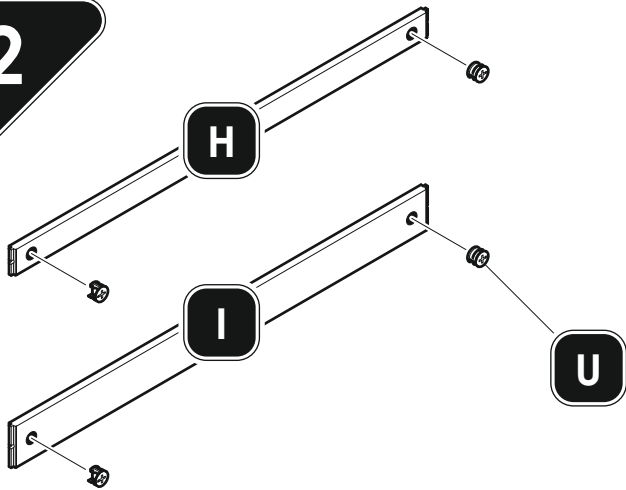

**i**

Arrow  
Flèche  
Flecha

Always ensure that the arrow on part **U** points towards the edge of the panel.  
Assurez-vous que la flèche sur la partie **U** soit dirigée vers le bord du panneau.  
Siempre asegúrese de que la flecha en la parte **U** apunta hacia el borde del panel.



3

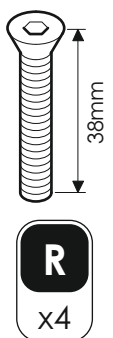
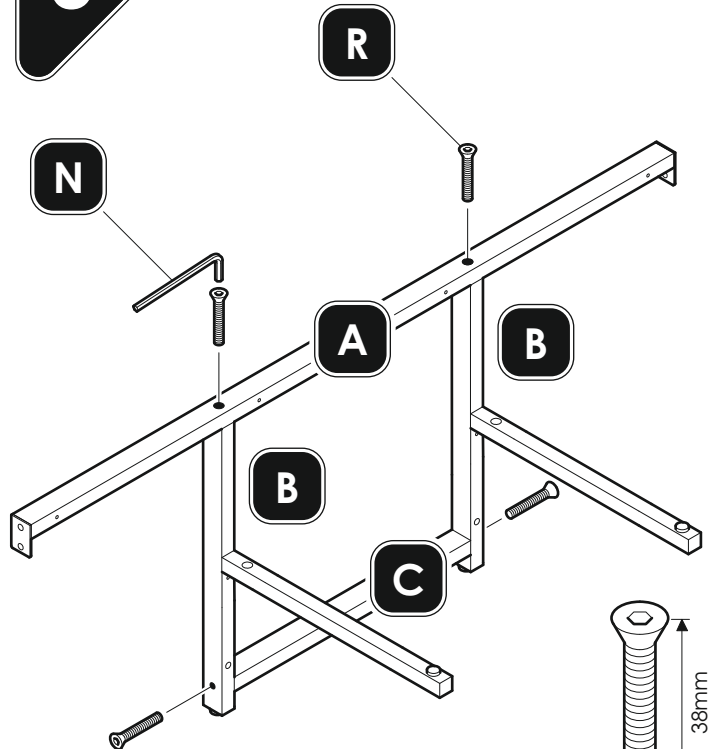

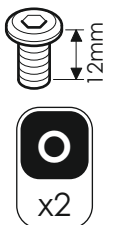
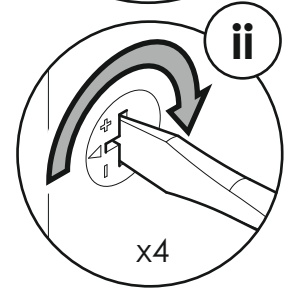
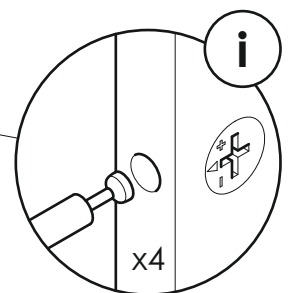
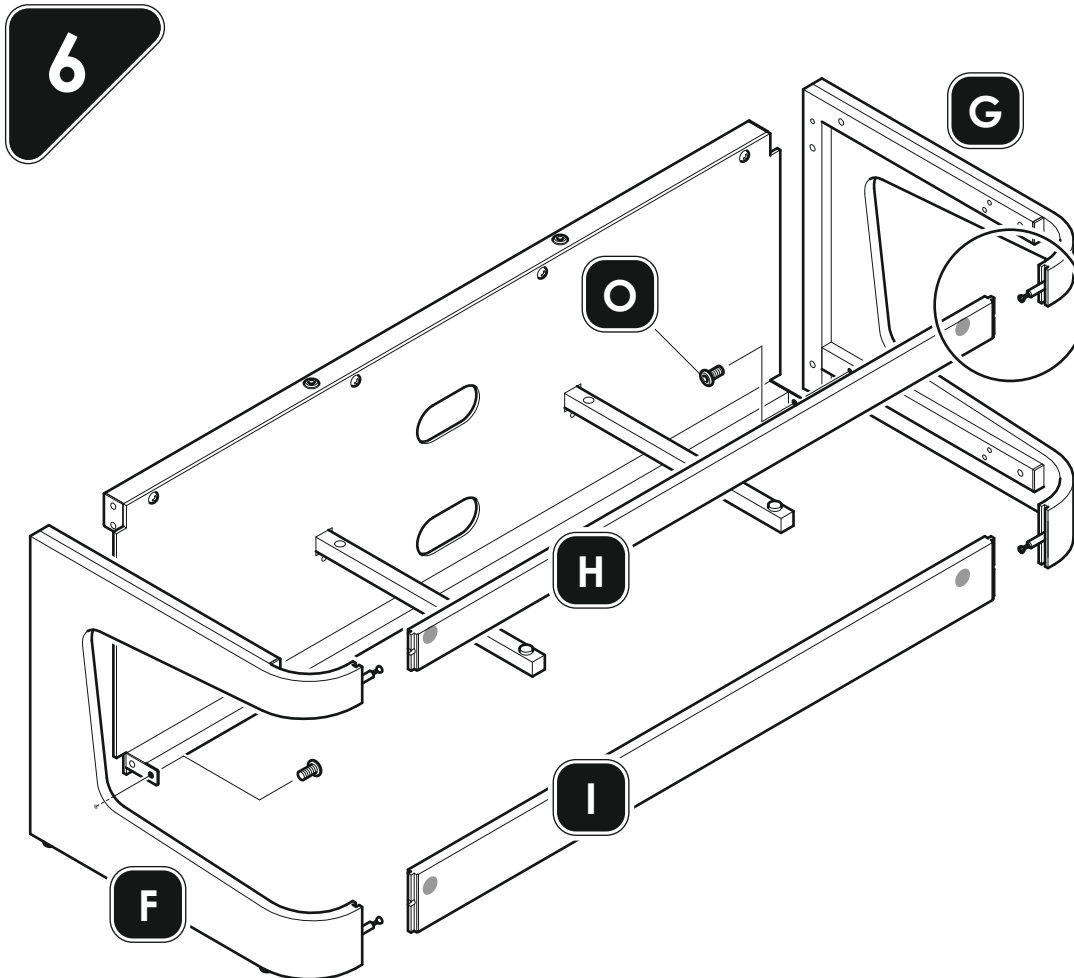
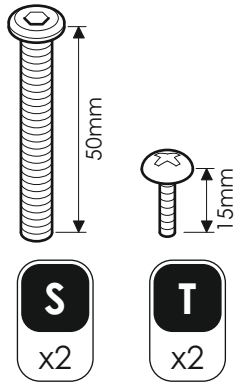
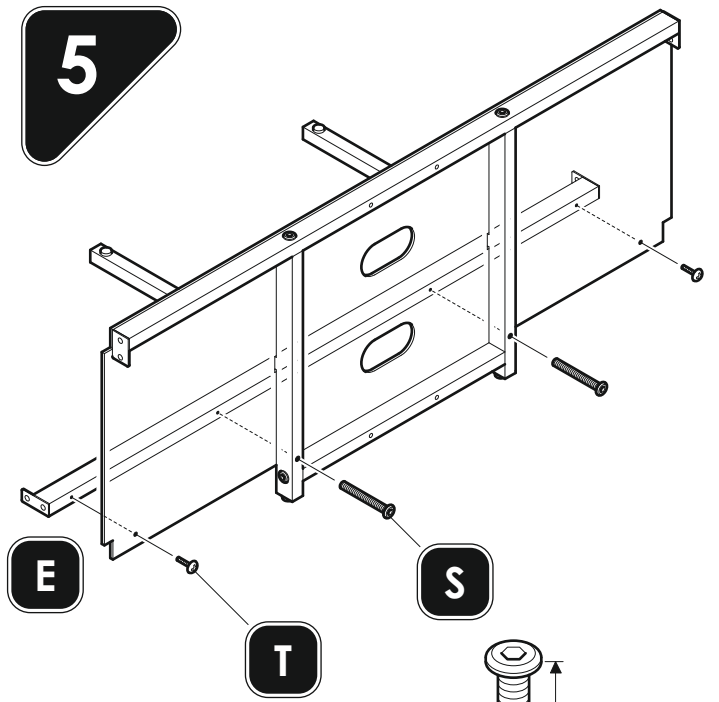
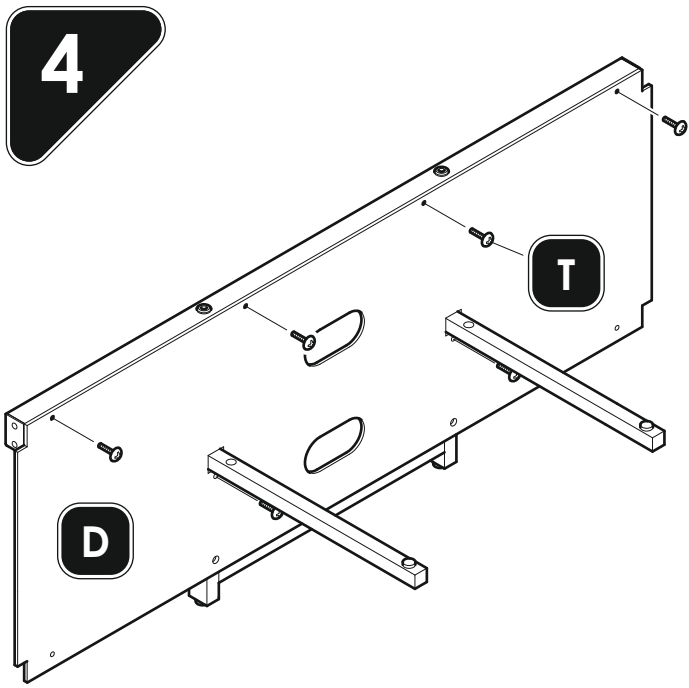

7

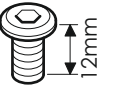
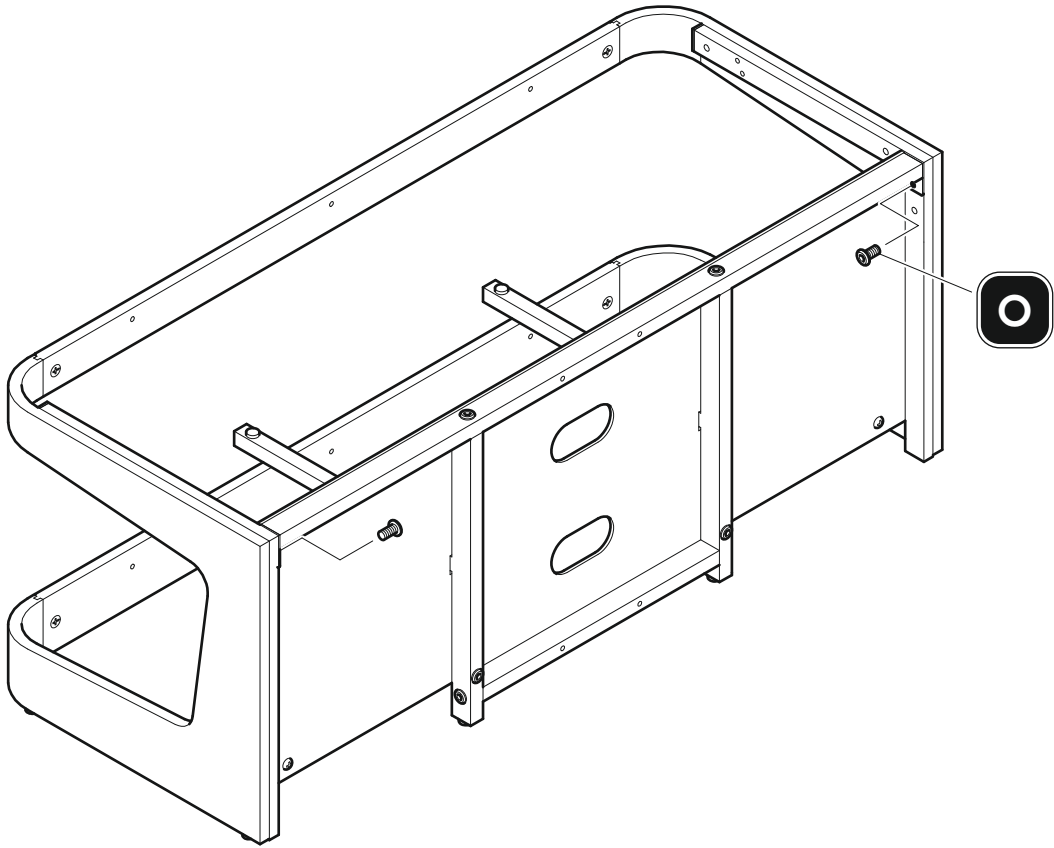

O  
x2

8

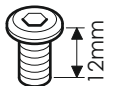
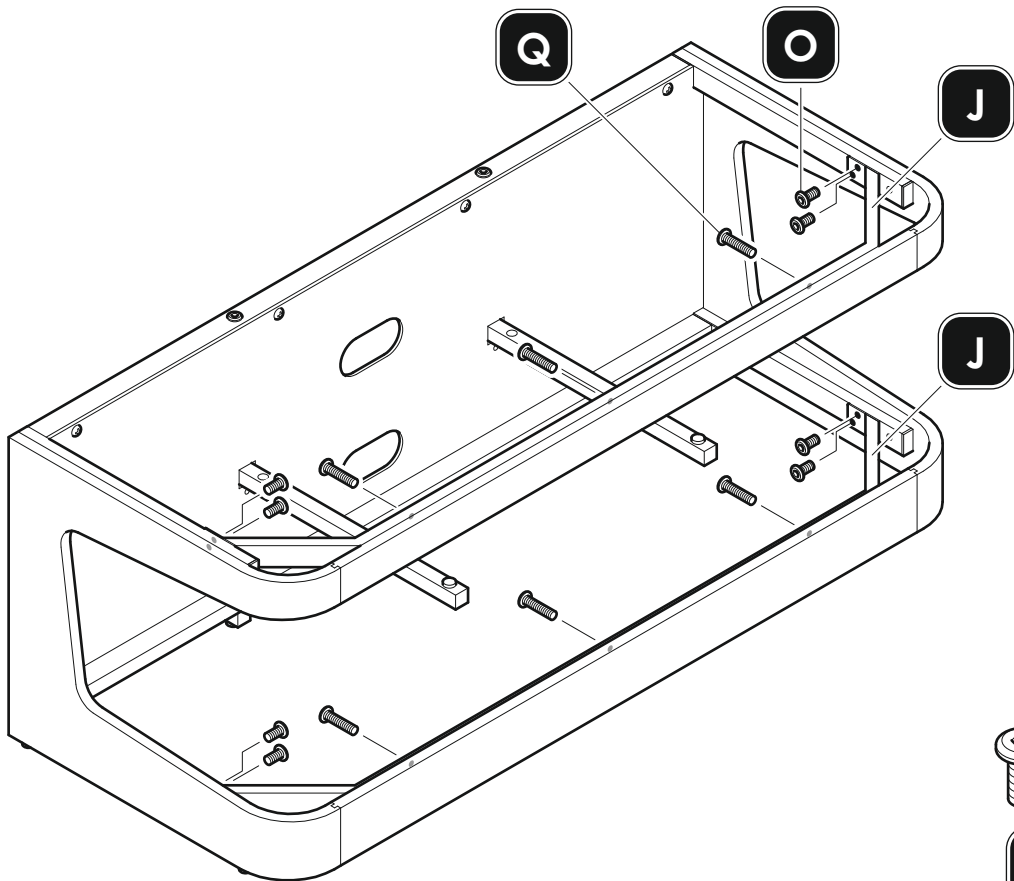

O  
x8

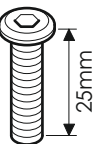

Q  
x6

9

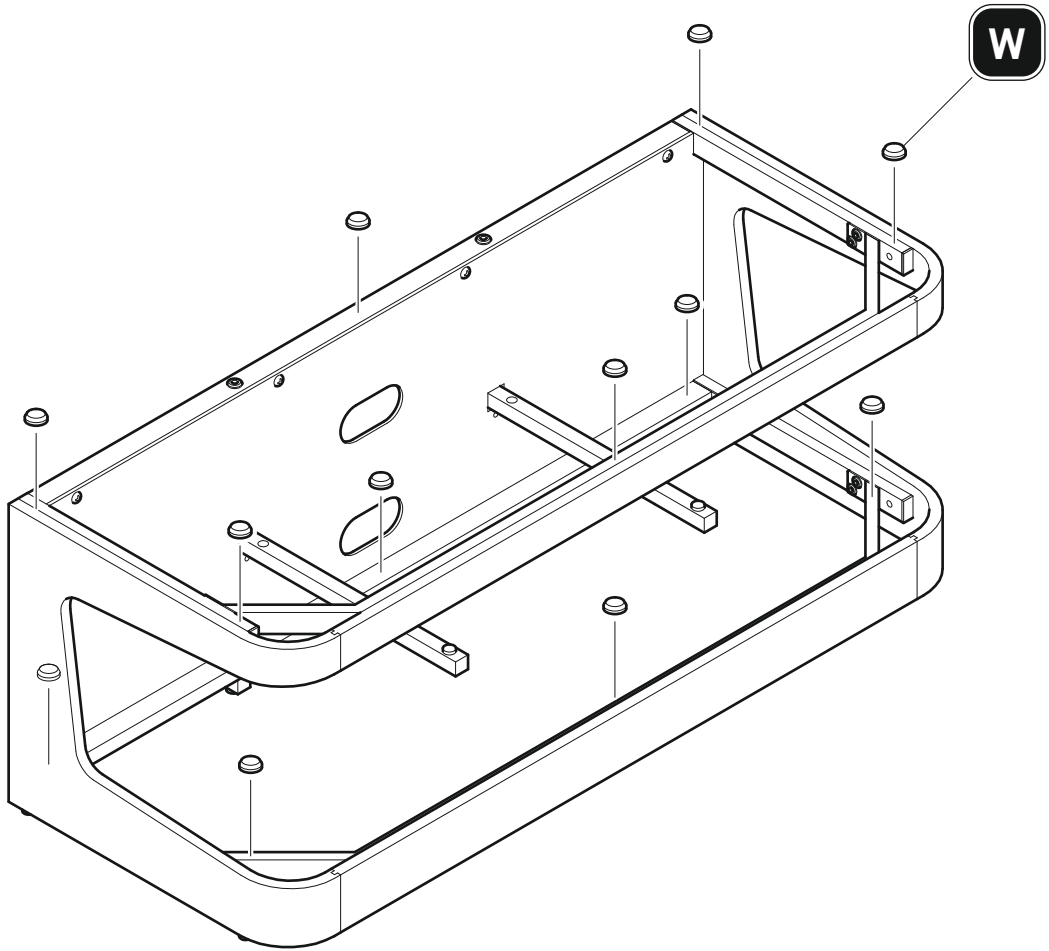

10

*i*

Do not over tighten  
*Ne serrez pas trop fort*  
No apriete demasiado

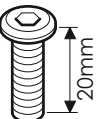
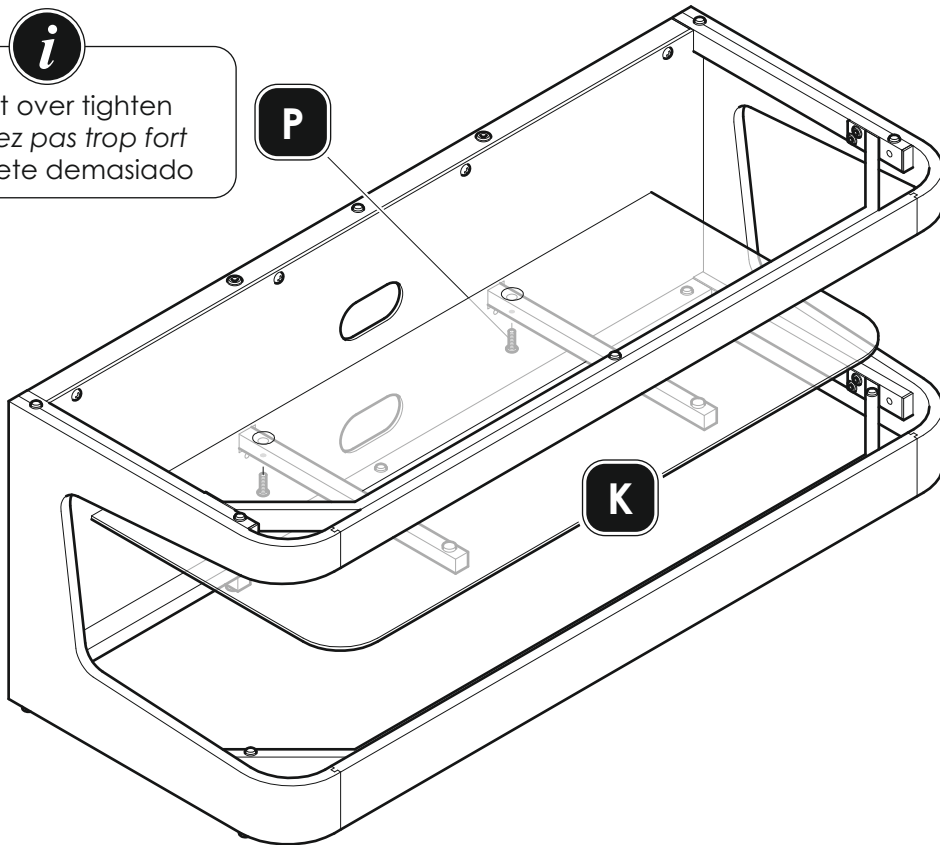

11

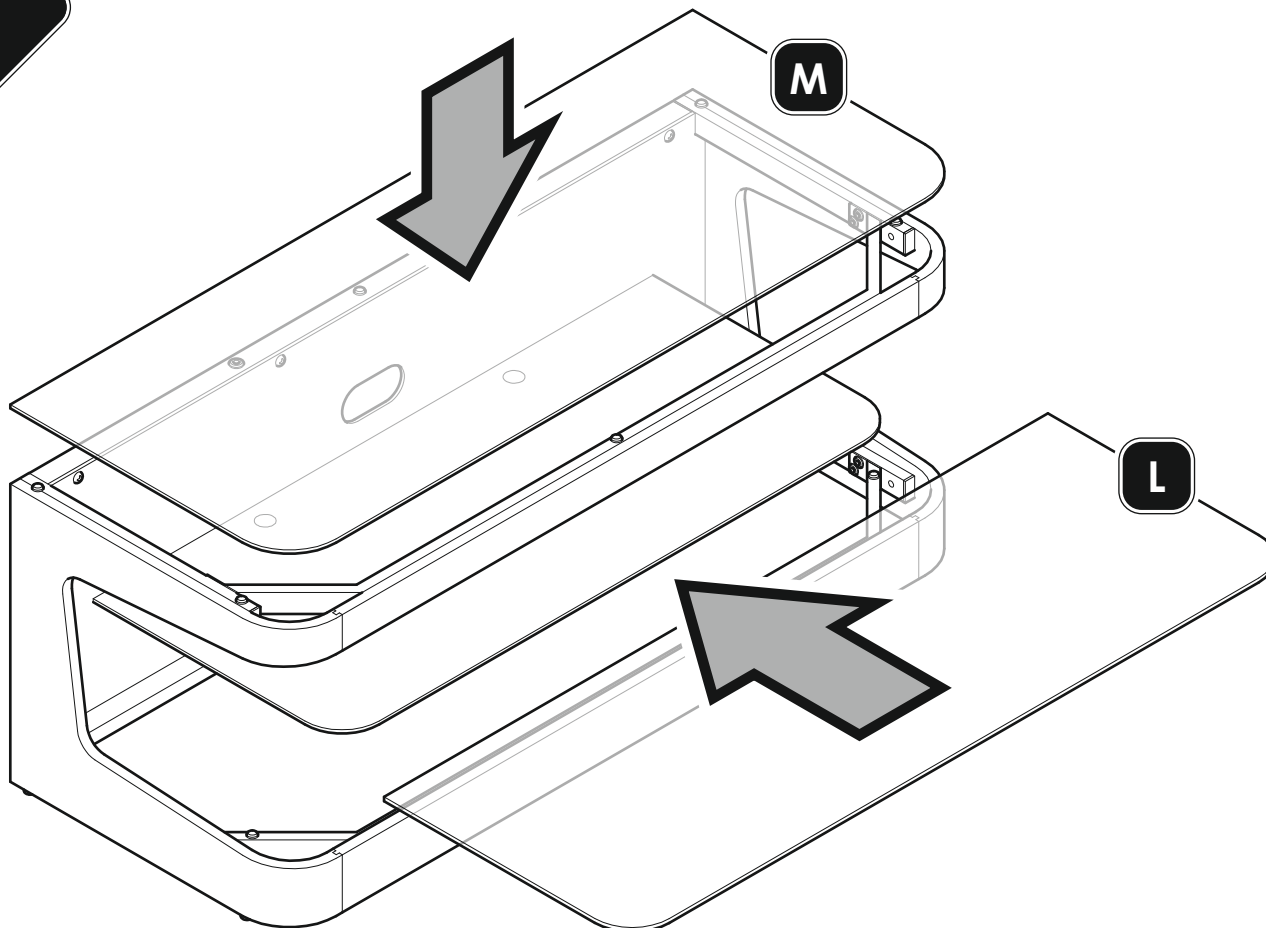

Optional  
Optionnel  
Opcional

Levelling  
Ajustez le niveau  
Nivelación

